



**MOBILE APP INTEGRATED
ELECTRONIC DARTBOARD**



Replacement Parts

Order direct at www.gldproducts.com
or call our Customer Service department at
(800) 225-7593

8 am to 4:30 pm Central Standard Time

GLD Products

Vtooth 1000 Dartboard

Item 42-1055

Staple your receipt here.

Important: A copy of your receipt will be needed to activate your warranty (see page 12).

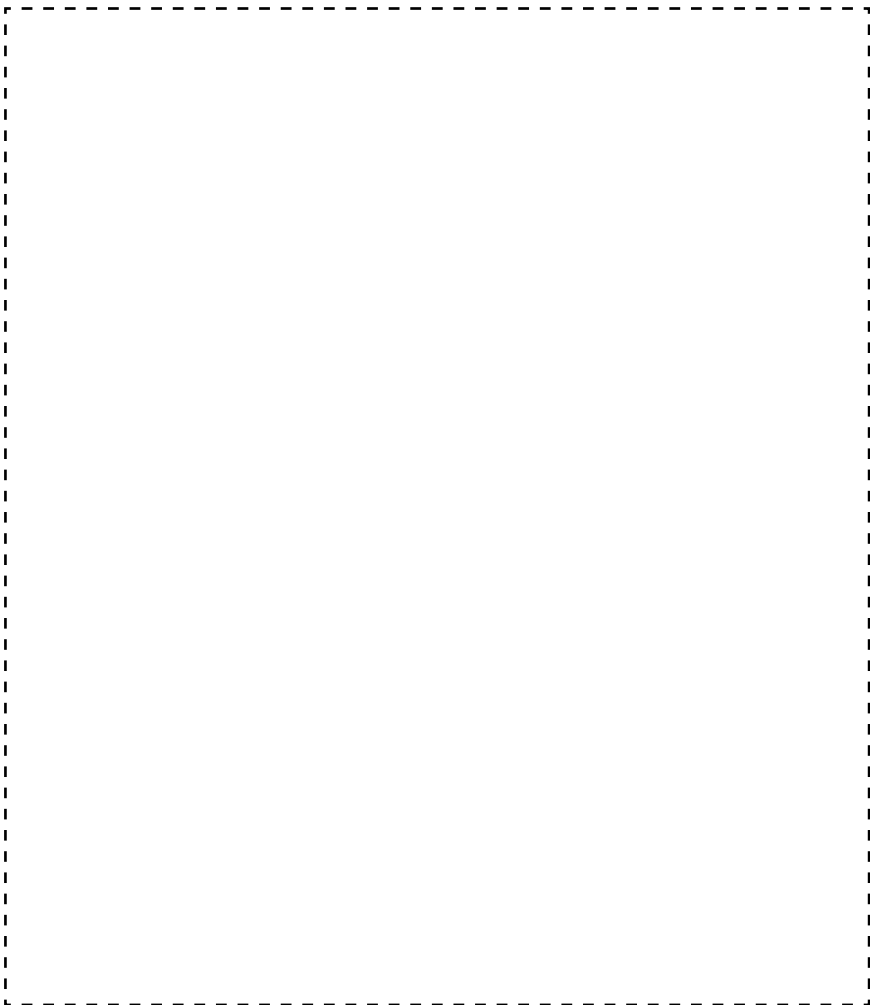

Congratulations and THANK YOU for purchasing the Vtooth 1000 Dartboard. You have chosen a product that should provide years of entertainment. To assist you with customer service and warranty claims, staple your receipt to the inside cover, then keep this manual in a safe place for future reference.

GLD Products

S84 W19093 Enterprise Drive

Muskego, WI 53150 USA

1-800-225-7593

Fax: 1-800-841-6944

Email: gld@gldmfg.com

Web: www.gldproducts.com

This manual may have been updated. For the latest manual visit the GLD products website. Este manual puede haber sido actualizado. Para obtener el último manual, visite el sitio web de GLD Products.



Place your package near the location where it will be used. Carefully unpack all components and verify you have all the correct pieces. If you notice missing or defective parts, please call us at:

1-800-225-7593



Please read and understand all instructions before beginning assembly.

This assembly will require 2 adults.



Choking Hazard

This game has small parts that may break free and present a choking hazard. Children should be supervised by an adult when playing this game.

FCC DELARATION OF CONFORMANCE

This device, FCC ID: 2AIBQ42-1055, complies with Part 15 of the FCC Rules. Operation is subject to the following two conditions: (1) this device may not cause harmful interference, and (2) this device must accept any interference received, including interference that may cause undesired operation.

CAUTION: Any changes or modifications made to this equipment may void the user's authority to operate this equipment.

IF YOU HAVE A WARRANTY CLAIM, CALL US FIRST:

Please refer to page 12.

GLD Products

Available 8 am to 4:30 pm Central Standard Time

S84 W19093 Enterprise Drive
Muskego, WI 53150 USA
1-800-225-7593
Fax: 1-800-841-6944
Email: gld@gldmfg.com
Web: www.gldproducts.com

For all claims, please have your receipt and item number when you call. The product item number can be found on the front cover.

If you are instructed to return the product for service, you are responsible for shipping the unit at your expense.

PRODUCT REGISTRATION

Important: The product registration form on page page 13 and a copy of your receipt must be completed and returned within 10 days of purchase to validate your warranty.

Online registration is also available. Go to www.gldproducts.com/index.php/registration or click on this link. Follow the online instructions.



WARNING: Parents - Please read instructions carefully. Not for use by children without adult supervision.

Thank you for purchasing the GLD Vtooth 1000 Dartboard. The computerized scoring system makes game playing easy and enjoyable.

IMPORTANT: This electronic dartboard operates using the GLD Live Dart Scorer application. The application must be installed on a compatible device that uses Bluetooth® communication.

TOOLS REQUIRED

- Tape Measure
- Nail or Marker
- Phillips Screwdriver
- Level
- Mounting Hardware (provided)
- 4 AA Batteries (not included)

UNPACKING THE DARTBOARD

After unpacking the game, it is important to save the original box, all packing material, and the receipt. These items will be needed if it ever proves necessary to return the game for service.

MOUNTING (PHYSICAL INSTALLATION)

Two methods for mounting the dartboard are available.

1. Use the two keyhole slots and mount the center of the dartboard following the illustration. The two screws are screwed into the wall until the screw head is 3/8" away from the wall. The dartboard is positioned so the two screw heads are inside the keyholes. Slide the dartboard down to secure. The head of the screw that is used must be larger than 1/4" and smaller than 3/8".
2. Four equally spaced holes are accessible from the front to drive in screws. With the dartboard held in place, four screws are driven in from the front, through the existing holes. Use 1/8" diameter screws. The head of the screw must fit inside the pocket.

Wall Anchors

1. Locate a stud and use wood screws or sheet metal type screws to secure the mounting bracket.
2. If a stud cannot be located or is not in the proper location, use the plastic anchors and screws.

Some common anchors are:

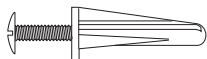

Plastic - Drill a snug hole in drywall and push the anchor in up to the head. When the screw is screwed into the anchor, the plastic will expand, locking the anchor in place. Do not use on thin paneling.

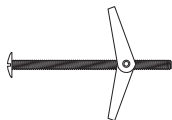

Toggle Bolt - Drill hole through wall. Hole must be large enough for the wings to pass through. Insert screw through the holes in the mounting bracket and thread the toggle wings just onto the screw. Fold the wings back and push through the hole until the wings spring open. Pull back on the screw to hold wings against the inside of the wall and tighten screw.

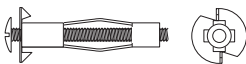

Hollow wall anchor - Drill a snug hole through the wall. Tap anchor into the hole until the prongs on the underside of the head are seated securely into the wall. Turn screw in and apply pressure to keep the anchor head from turning. Tighten screw until resistance is felt. Do not over tighten. Turn screw out to remove. Anchor will stay and screw can be replaced.

Other methods are available. Consult a hardware store if questions arise.

Mounting Using the Keyhole Slots

1. Choose a location that has at least 10 feet of open floor space in front of the board. Locate and use a wall stud for mounting whenever possible.
2. Determine the location for the dartboard. Place a mark on the wall 68" (172.7 cm) from the floor. This mark is the final position of the center of the dartboard (bullseye).
3. Locate studs and use wood screws or sheet metal screws to secure the dartboard if the mark is on the stud. The head of the screw must be larger than 1/4" and smaller than 3/8".
4. If the mark is not over a stud, use the mounting hardware that came with your dartboard.
5. Measure 8-5/8" (21.9 cm) directly up from the bullseye mark and place a mark on the wall. Then measure down 8-5/8" (21.9 cm) from the bullseye mark and place a mark on the wall. Use a level to check that all marks are vertical.
6. Drill pilot holes at the two marks. These are for the mounting screws.
7. If using wall anchors, follow the instructions under Wall Anchors on page 5.
8. Insert screws into anchors until a 1/4" (6.5 mm) gap is left between the wall and the screw head.
9. Hold the dartboard so the two screw heads fit into the lower part of the keyholes. The dartboard should slide down 1/2 inch and the screw heads will hold it on the wall.
10. Screws can be tightened or loosened to provide a secure mounting.

Mounting Using the Four Holes From the Front

1. Choose a location that has at least 10 feet of open floor space in front of the board. Locate and use a wall stud for mounting whenever possible.
2. Two people are needed for this step. Hold board on the wall. Position center of bullseye 68" from the floor. Level the board. Hold in place.
3. Locate the four mounting holes on the front of the board. Use a marker or nail to mark the position of the board through the four mounting holes onto the wall. Remove the board.
4. Drill four pilot holes on the marks created in Step 3.
5. If using plastic anchors: drill the holes so the anchors fit snugly. Push anchors into place.
6. Line up dartboard over anchors. Screw board into place. The screws will expand the anchors.
7. After the board is mounted, the bullseye should be 68" (173 cm) above the floor.

Create the Toe Line

Place a toe line 96" from the face of the board for the throwing distance. Adhesive tape or masking tape, 2' long by 2-1/2" wide, may be used. GLD products also offers a Viper® Laser Throw Line and a Dart Mat for this purpose.

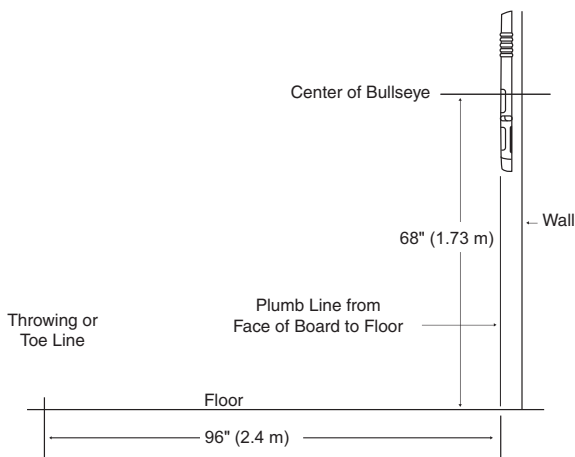

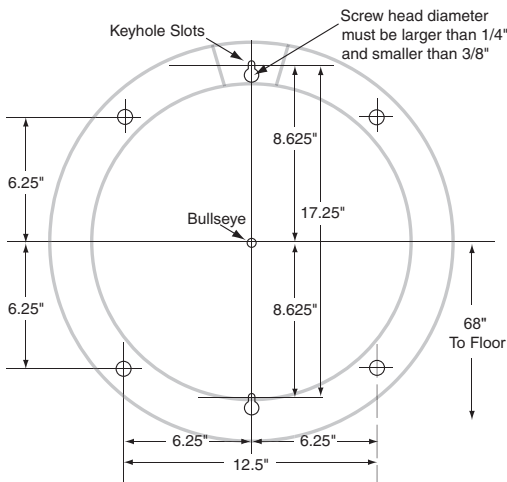

Mounting holes viewed from back

Four holes for front mounting. Use #10 screw, 5/16" max. head diameter.

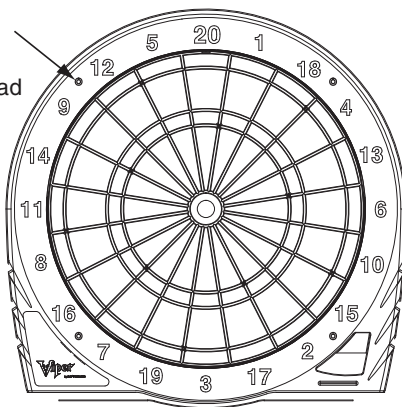

POWER INSTALLATION

The dartboard is designed to be powered by 4 AA batteries (not provided). Open the battery cover on the front to install the batteries. To conserve batteries, this dartboard is equipped with a sleep mode and an auto power-off mode. If the dartboard is not being used, it will automatically enter sleep mode after 5 minutes and will turn off after 15 minutes.

- Always install the correct size and grade of battery suitable for the intended use.
- Replace all batteries of a set at the same time, taking care not to mix old and new ones or batteries of different types.
- Clean the battery contacts and also those of the device prior to battery installation.
- Ensure the batteries are installed correctly with regard to polarity (+ and -).
- Remove batteries from equipment which won't be used for an extended period of time.
- Remove used batteries promptly.

This dartboard has a built in a sleep mode (after 5 minutes of inactivity) and shut-off mode (after 15 minutes of inactivity). It can be triggered back to operation by hitting any segment or pressing any button. To turn the dartboard off, press and release the ON/OFF button.

PROTECTIVE FILM

This electronic dartboard has a clear protective film over the entire display and button area to prevent scratching during shipping. It is recommended that you remove this film for easier reading of the display. To remove, simply lift edge, peel off and discard.



WARNING: Not for use by children without adult supervision. Darts are not toys and may cause injury if used improperly. Everyone must stand behind the dart thrower.

IMPORTANT NOTES

1. This game is designed for use with 3/4" length soft-tip darts only! Never use metal tipped darts or longer soft-tip darts on this dartboard! Metal tipped darts will seriously damage the circuitry, the computer, and electronic operation of the dartboard.
2. Electronic and mechanical reaction time is required between shots. If two shots occur too close together, pull out second dart and rethrow to properly record your score.
3. Do not use excessive force when throwing darts. Throwing a dart too hard will cause frequent tip breakage and cause excessive wear on the board.
4. Do not spill liquids on the dartboard. Do not use spray cleaners that contain ammonia or other harsh chemicals, as they may damage the dartboard. Instead, we suggest regular dusting with a damp cloth. Make sure the batteries are removed and use a mild detergent and a damp cloth for more vigorous cleaning.
5. This game is for indoor use only.

Helpful Tip: To prevent dart tips from loosening, twist the dart to the right (clockwise) when pulling it from the board. This motion will make dart removal easier and will prolong the life of your dart tips.

Segment Scoring	Scoring Rules
Single scoring segment	score times 1
Double scoring segment	score times 2
Triple scoring segment	score times 3
Outer bullseye	25 times 1
Center bullseye	25 times 2

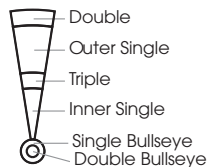

DOWNLOAD APP

This board operates with an app interface and requires the app to function. The app is periodically updated with additional games and features at no cost to the user.

Android™ Operating System Version 4.4 or Higher

- Use the device to access the internet.
- Go to play.google.com.
- Search for GLD Dart Board.
- Install the Wireless Electronic Dart Board app.

Apple Operating System

- Use the Apple® device to access the internet and go to Apple App Store.
- Search for Viper Electronic Dartboard.
- Install the Wireless Electronic Dart Board app.

Apple and Apple App Store are trademarks of Apple Inc., registered in the U.S. and other countries.

Android is a trademark of Google Inc.

The *Bluetooth®* word mark and logos are registered trademarks owned by Bluetooth SIG, Inc. and any use of such marks by GLD Products is under license. Other trademarks and trade names are those of their respective owners.

Using the App

1. Turn on your device's Bluetooth® function.
2. Turn on the dartboard.
3. Open the app.
4. The dartboard will be automatically connected with the app.

The apps are also available through www.viperdartslinkup.com.

OPERATION OF THE DARTBOARD

This dartboard is operated with the keys ON/OFF, BOUNCE OUT, MISS and NEXT PLAYER. There is one score display and a green LED connection indicator.

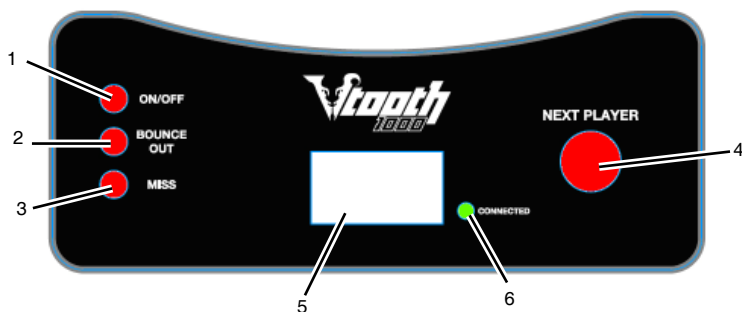

1. ON/OFF button: Press this button to turn the dartboard on or off.
2. BOUNCE OUT button: Press this button to eliminate the score that was recorded by the GLD Dartboard application (app) for the last throw.
3. MISS button: Press this button to record a missed dart by the GLD Dartboard application (app).
4. NEXT PLAYER button: Press this button to switch to next player.
5. Score Display: This display shows the score of the current dart thrown.
6. Connection Indicator: This LED indicator is green when the dartboard is connected with the GLD Dartboard application (app). The app game screen will display "Dartboard Connected".

ONE YEAR LIMITED WARRANTY

The Manufacturer warrants to the original retail purchaser that this product is free from defects in material and workmanship under normal use and conditions for a period of one year from the date of original purchase. The Manufacturer's liability is limited to the repair or replacement, at its option, of any defective product and shall not include any liability for indirect, incidental or consequential damages of any kind.

Should this product become defective due to material or workmanship within the warranty period, contact our Customer Service Department. This warranty is not transferable and does not cover normal wear and tear or damage caused by improper usage, negligence, misuse, abuse, transportation damage, acts of nature, or accident (including failure to follow the instructions in this manual). It does not cover expendable items such as batteries, light bulbs, fuses, accessories, cosmetic parts and other items that wear out due to normal usage, including felt covered areas of the playing surface. This warranty is also void if the product is disassembled and reassembled, damaged, modified from its original state, or used for other than indoor personal residential use (no commercial or rental applications).

This warranty gives you specific legal rights, and you may have other rights which vary from state to state.

IF YOU HAVE A WARRANTY CLAIM, CALL US FIRST (8 - 4:30 CST):

Please have your receipt and item number (found on the front cover) when you call.

GLD Products

S84 W19093 Enterprise Drive

Muskego, WI 53150 USA

1-800-225-7593

Fax: 1-800-841-6944

Email: gld@gldmfg.com

Web: www.gldproducts.com

If you are instructed to return the product for service, you are responsible for shipping the unit at your expense to the above address in packaging that will protect against further damage. All warranty or repair requests require a Return Authorization Number prior to returning the item.

PRODUCT REGISTRATION

Important: The product registration form on page page 13 must be completed and returned along with a copy of your receipt within 10 days of purchase to validate your warranty.

On-line registration is also available.

Go to <http://www.gldproducts.com/index.php/registration> or click on this link. Follow the on-line instructions.

REGISTER YOUR PRODUCT

Mail in this completed form with a copy of your receipt (do not staple), within 10 days of purchase. This protects your warranty and will help us develop new products!

GLD Products
Warranty Department
S84 W19093 Enterprise Drive
Muskego, WI 53150 USA



GAMES TABLES	HOME CASINO
GAMES AND ACCESSORIES	BILLIARD CUES
BILLIARD ACCESSORIES	DARTBOARDS
SOFT-TIP DARTS	STEEL-TIP DARTS
FLIGHTS AND SHAFTS	DART CASES AND ACCESSORIES

Name	Date of Purchase
Address	Phone-Day
City	Phone-Evening
State Zip	Email
Purchase Price:	Item: 42-1055 Vtooth 1000 Dartboard
Store Name:	

Remember to attach a copy of your receipt.

This page left intentionally blank.



www.gldproducts.com

GAME TABLES
HOME CASINO
GAMES AND ACCESSORIES
BILLIARD CUES
BILLIARD ACCESSORIES
DARTBOARDS
SOFT-TIP DARTS
STEEL-TIP DARTS
FLIGHTS AND SHAFTS
DART CASES AND ACCESSORIES



PROUD MANUFACTURER OF



S84 W19093 Enterprise Drive • Muskego, WI 53150 USA

262.679.8730 or 1.800.225.7593 tele

262.679.8738 or 1.800.841.6944 fax

Email: gld@gldmfg.com

www.gldproducts.com