



**Sirius Electronic Dartboard**

Item 42-1029 A

# SIRIUS ELECTRONIC DARTBOARD

## Replacement Parts

Order direct at [www.gldproducts.com](http://www.gldproducts.com)  
or call our Customer Service department at  
**(800) 225-7593**  
8 am to 4:30 pm Central Standard Time

**Staple your receipt here.**

**Important:** A copy of your receipt will be needed to activate your warranty (see page 38).

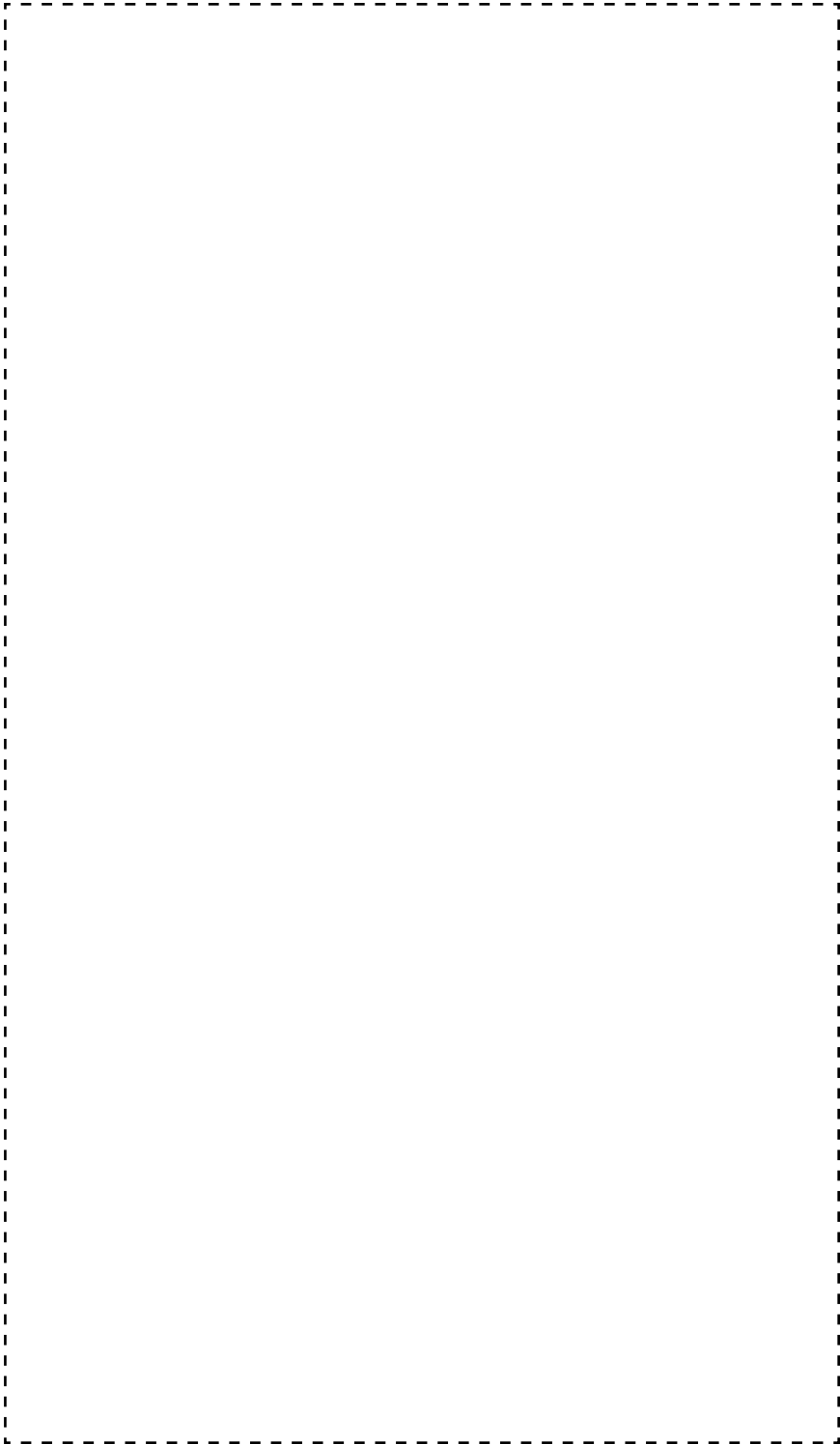



***Congratulations and THANK YOU for purchasing the Sirius Electronic Dartboard. You have chosen a product that should provide years of entertainment. To assist you with customer service and warranty claims, staple your receipt to the inside cover, then keep this manual in a safe place for future reference.***

**GLD Products**

S84 W19093 Enterprise Drive  
Muskego, WI 53150 USA  
1-800-225-7593  
Fax: 1-800-841-6944  
Email: [gld@gldmfg.com](mailto:gld@gldmfg.com)  
Web: [www.gldproducts.com](http://www.gldproducts.com)

This manual may have been updated. For the latest manual visit the GLD products website.

	<p>Place your package near the location where it will be used. Carefully unpack all components and verify you have all the correct pieces.</p> <p>If you notice missing or defective parts, please call us at: <b>1-800-225-7593</b></p>
-------------------------------------------------------------------------------------	----------------------------------------------------------------------------------------------------------------------------------------------------------------------------------------------------------------------------------------------

	<p>Please read and understand all instructions before beginning assembly.</p> <p><b>This assembly will require an adult.</b></p>
-------------------------------------------------------------------------------------	----------------------------------------------------------------------------------------------------------------------------------

	<p><b>Choking Hazard</b> This game has small parts that may break free and present a choking hazard. Children should be supervised by an adult when playing this game.</p>
-------------------------------------------------------------------------------------	--------------------------------------------------------------------------------------------------------------------------------------------------------------------------------

**IF YOU HAVE A WARRANTY CLAIM, CALL US FIRST:**

Please refer to page 38.

**GLD Products**

Available 8 am to 4:30 pm Central Standard Time

S84 W19093 Enterprise Drive  
Muskego, WI 53150 USA  
1-800-225-7593  
Fax: 1-800-841-6944  
Email: [gld@gldmfg.com](mailto:gld@gldmfg.com)  
Web: [www.gldproducts.com](http://www.gldproducts.com)

For all claims, please have your receipt and item number when you call. The product item number can be found on the front cover.

**If you are instructed to return the product for service, you are responsible for shipping the unit at your expense.**

**PRODUCT REGISTRATION**

**Important: The product registration form on page 39 and a copy of your receipt must be completed and returned within 10 days of purchase to validate your warranty.**

Online registration is also available. Go to [www.gldproducts.com/index.php/registration](http://www.gldproducts.com/index.php/registration) or click on this link. Follow the online instructions.



**WARNING: Parents** - Please read instructions carefully. Not for use by children without adult supervision.

Thank you for purchasing the GLD Sirius Electronic Dartboard. The computerized scoring system makes game playing easy and enjoyable. With 43 games and over 200 options to choose from, beginners and more advanced players will find challenging games to suit them.

**TOOLS REQUIRED**

- Tape measure
- Nail or marker
- Phillips screwdriver
- Level
- Mounting hardware (provided)
- 3 AA batteries (not provided)

## UNPACKING THE GAME

After unpacking the game, it is important to save the original box, all packing material, and the receipt. These items will be needed if it ever proves necessary to return the game for service.

## MOUNTING (PHYSICAL INSTALLATION)

Use the two keyhole slots and mount the center of the dartboard following the illustration. The two screws are screwed into the wall until the screw head is 3/8" away from the wall. The dartboard is positioned so the two screw heads are inside the keyhole. Slide the dartboard down to secure. The head of the screw that is used must be larger than 3/16" and smaller than 5/16".

### Wall Anchors

A wall with studs is the most common type of wall to mount the dartboard.

1. Locate a stud and use wood screws or sheet metal type screws to secure the dartboard.
2. If a stud cannot be located or is not in the proper location, use an anchor that is suitable for the type of wall.

Some common anchors are:

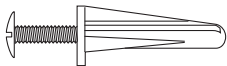

**Plastic** - Drill a snug hole in drywall and push the anchor in up to the head. When the screw is screwed into the anchor, the plastic will expand, locking the anchor in place. Do not use on thin panelling.

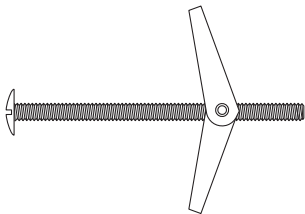

**Toggle Bolt** - Drill hole through wall. Hole must be large enough for the wings to pass through. Insert screw through the holes in the dartboard and thread the toggle wings just onto the screw. Fold the wings back and push through the hole until the wings spring open. Pull back on the screw to hold wings against the inside of the wall and tighten screw.

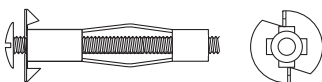

**Hollow wall anchor** - Drill a snug hole through the wall. Tap anchor into the hole until the prongs on the underside of the head are seated securely into the wall. Turn screw in and apply pressure to keep the anchor head from turning. Tighten screw until resistance is felt. Do not over tighten. Turn screw out to remove. Anchor will stay and screw can be replaced.

Other methods are available. Consult a hardware store if questions arise.

**Mounting Using the Keyhole Slots**

Refer to the illustrations on the following pages.

1. Choose a location that is near an electrical outlet and has at least 10 feet of open floor space in front of the board. Locate and use a wall stud for mounting whenever possible.
2. Determine the location for the dartboard. Place a mark on the wall 68 inches (172.7 cm) from the floor. This mark is the final position of the center of the dartboard (bullseye).
3. Locate studs and use wood screws or sheet metal screws to secure the dartboard if the mark is on the stud. The head of the screw must be larger than 3/16" and smaller than 5/16".
4. If the mark is not over a stud, use the mounting hardware that is appropriate for your type of wall.
5. Measure 75-5/8" (192 cm) up from the floor and place a mark on the wall. Then measure sideways 4-7/8" (12.4 cm) and place a mark on the wall. Use a level to check that all marks are horizontal.
6. Drill pilot holes at the two marks. These are for the mounting screws.
7. If using wall anchors, follow the instructions under *Wall Anchors* on page 5.
8. Insert screws into anchors until a 3/8" (9.5 mm) gap is left between the wall and the screw head.
9. Hold the dartboard so the two screw heads fit into the lower part of the keyholes. The dartboard should slide down 1/2 inch and the screw heads will hold it on the wall.
10. Screws can be tightened or loosened to provide a secure mounting.

**Create the Toe Line**

Place a toe line 96" from the face of the board for the throwing distance. Adhesive tape or masking tape, 2' long by 2-1/2" wide, may be used. GLD products offers a Viper Throwing Line and a Dart Mat for this purpose.

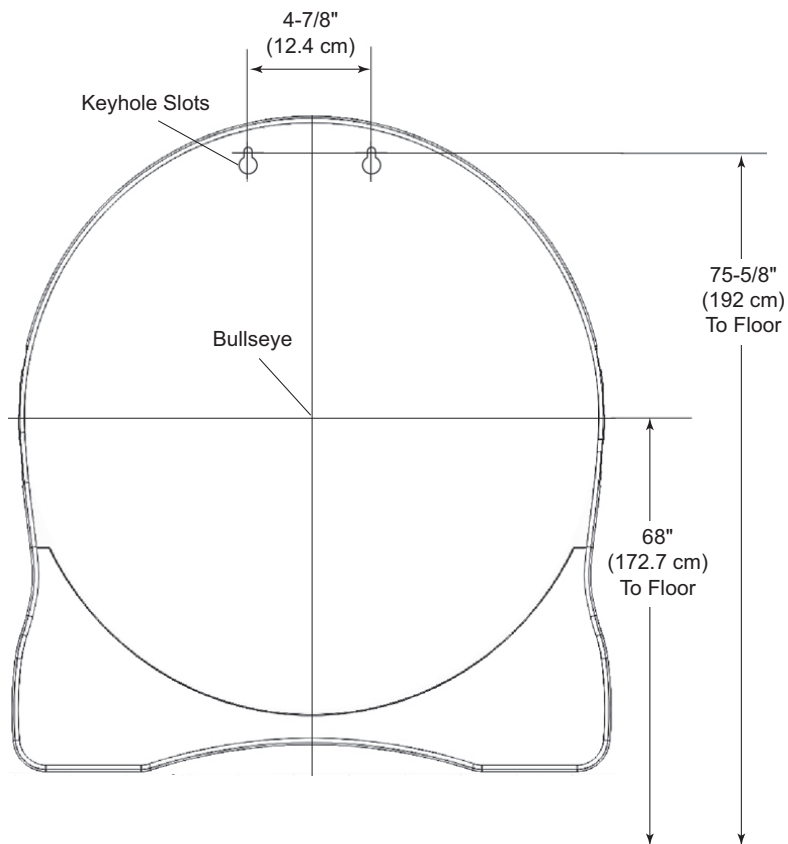
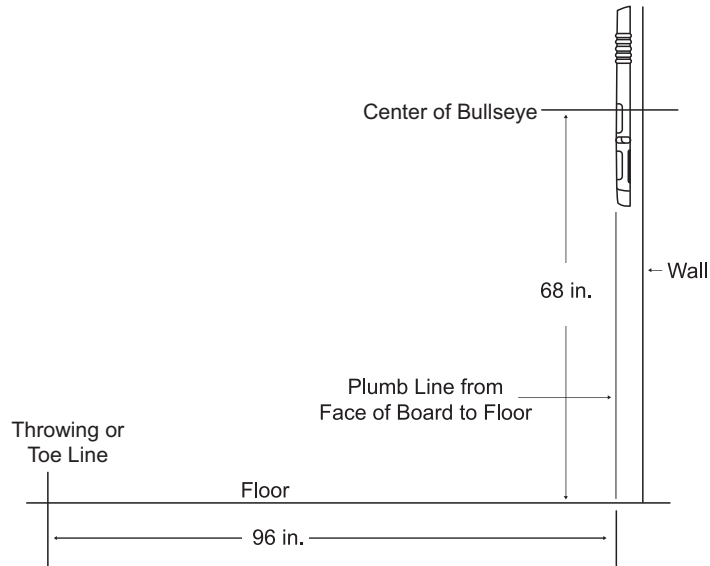

**POWER INSTALLATION**

The dartboard is powered by 3 AA batteries (not provided). The battery compartment can be opened from the back to install the batteries. To conserve batteries, this dartboard is equipped with a sleep mode and an auto power-off mode.

Always install the correct size and grade of battery suitable for the intended use. Replace all batteries of a set at the same time, taking care not to mix old and new ones, or batteries of different types. Clean the battery contacts and also those of the device prior to battery installation. Ensure the batteries are installed correctly with regard to polarity (+and -).

Remove batteries from equipment which is not to be used for an extended period of time. Remove exhausted batteries promptly.

If the dartboard is not being used, it will automatically enter sleep mode after 3 minutes. Press any button to resume play. If the dartboard is not being played for 30 minutes, the dartboard will turn off automatically.

1. The board is not intended for children under the age of 9 years old.
2. The board must only be used with 3 AA batteries.

**PROTECTIVE FILM**

This electronic dartboard has a clear protective film over the entire display and button area to prevent scratching during shipping. It is recommended that you remove this film for easier reading of the display. To remove, simply lift edge, peel off and discard.

	<p><b>WARNING: Not for use by children without adult supervision. Darts are not toys and may cause injury if used improperly. Everyone must stand behind the dart thrower.</b></p>
-------------------------------------------------------------------------------------	------------------------------------------------------------------------------------------------------------------------------------------------------------------------------------

**IMPORTANT NOTES**

1. During shipping or in the course of normal play, it is possible for scoring segments of this board to become temporarily jammed, resulting in a “frozen” board. If this occurs, the built-in **Self Diagnostic Function** of the e-BOARD Computer will be activated automatically. Your dartboard will run a self-test routine to determine which segment is stuck. An error message will flash on the display together with the number for the “Frozen” segment.

<b>Error Code</b>	<b>Malfunction</b>
E 25/D	Inner Bullseye
E 25	Outer Bullseye
E 30	Bounce Button
E 31	Play/Next Button
E 33	Game Button
E 34	Player Button
E 35	Option Button
E 0X	Single segment for the number displayed at "X"
E dX	Double segment for the number displayed at "X"
E tX	Triple segment for the number displayed at "X"



Take the following steps immediately when the error message appears.

- a. Find the “frozen” segment according to the display.
  - b. Press firmly down on the “frozen” segment until it breaks free and the loose fit is restored. Once the “frozen” segments are loosened, the error message should be gone and the board will continue to operate normally.
2. This game is designed for use with 1" maximum length soft-tip darts only! Never use metal tipped darts or longer soft-tip darts on this dartboard! Metal tipped darts will seriously damage the circuitry, the e-BOARD computer, and electronic operation of the dartboard.
  3. Electronic and mechanical reaction time is required between shots. If two shots occur too close together, pull out second dart and rethrow to properly record your score.
  4. Do not use excessive force when throwing darts. Throwing a dart too hard will cause frequent tip breakage and cause excessive wear on the board.
  5. Do not spill liquids on the dartboard. Do not use spray cleaners that contain ammonia or other harsh chemicals, as they may damage the dartboard. Instead, we suggest regular dusting with a damp cloth. Make sure the game is OFF and use a mild detergent and a damp cloth for more vigorous cleaning.
  6. This game is for indoor use only.
- Helpful Tip: To prevent dart tips from loosening, twist the dart to the right (clockwise when pulling it from the board). This motion will make dart removal easier and will prolong the life of your dart tips.

## GAME OPERATIONS

### Segment Scoring

- Single scoring segment
- Double scoring segment
- Triple scoring segment
- Outer bullseye
- Center bullseye

### Scoring Rules

- score times 1
- score times 2
- score times 3
- 25 times 1
- 25 times 2

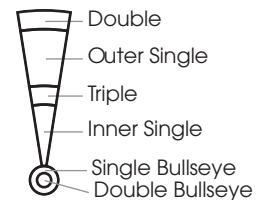

## QUICK START - IF YOU JUST WANT TO START THROWING DARTS

1. Turn game ON by pressing the POWER button.
2. Press the PLAY/NEXT button.

**Note:** The default game is G01 Count Up with 2 players.

3. Take turns throwing darts. Press PLAY/NEXT to switch players. The first player to get their score to 100 wins.

**DARTBOARD GAME MENU**

<b>Game</b>	<b>Name</b>	<b>Options</b>	<b>Players</b>
G01	Count Up	9	1-8
G02	301	4	1-8
G03	501	4	1-8
G04	601	4	1-8
G05	701	4	1-8
G06	801	4	1-8
G07	901	4	1-8
G08	301 League	4	4
G09	501 League	4	4
G10	601 League	4	4
G11	701 League	4	4
G12	801 League	4	4
G13	901 League	4	4
G14	Round-The-Clock	12	1-8
G15	Simple Cricket	3	1-8
G16	Standard Cricket	3	1-8
G17	Cut Throat Cricket	3	1-8
G18	Scram Cricket	1	2
G19	Hi-Score	10	1-8
G20	Shoot Out	10	1-8
G21	Shanghai	12	1-8
G22	Double Down	1	1-8
G23	Forty One	1	1-8
G24	All Fives	5	1-8
G25	Big 6	5	1-8
G26	Overs	3	2-8
G27	Unders	3	2-8
G28	Baseball	3	1-8
G29	By 5's©	1	1-8
G30	By 10's©	1	1-8
G31	By Odd's©	1	1-8
G32	Killer	30	2-8
G33	9 lives	7	2-8
G34	Halve-It	1	1-8
G35	Bingo	4	1-8
G36	21 Points	7	1-8

Game	Name	Options	Players
G37	Nine Dart Century	3	1-8
G38	Best of Nine	5	1-8
G39	Hound and Hare	5	2
G40	Shooting I	1	1-8
G41	Shooting II	1	1-8
G42	Shooting III	1	1-8
G43	Shooting IV	1	1-8

**DARTBOARD FUNCTIONS**

**Buttons and Game Display**

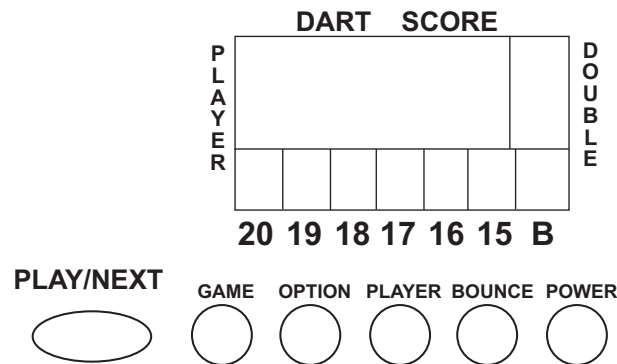

1. **PLAY/NEXT** button: Press to start a game. Also used to change players during a game.
2. **GAME** button: Press repeatedly to scroll through the list of games.
3. **OPTION** button: Press to select the options for the game. Applies to all players. Before starting a G02 and G03 game, press and release to select **DOUBLE IN/DOUBLE OUT** options.
4. **PLAYER** button: Press to select the number of players for the game.
5. **BOUNCE** button: Used to delete bounce-out darts. Press to display score to be eliminated. Press and hold to delete that score.
6. **POWER** button: Press to turn power ON. Press and hold to turn power off.
7. **Scoring Display**: Shows the active player with scoring information.
  - Player Number
  - Darts thrown
  - Score
  - Marks for Cricket Games
  - Double In/Double Out Setting.

**READ FIRST - OPERATION**

1. Press **POWER** button on the front panel of the dartboard to turn the dartboard ON. At power-up the dartboard will play a fanfare.
2. Press the **GAME** button to scroll through the game menu.
3. Press the **PLAYER** button to select the number of players. The maximum number of players is limited to 8.
4. Press the **OPTION** button to select the designed options/difficulties of the game for all players. For Count-Down and 301 League games, players can also select Double In/double Out options before starting, by pressing the **OPTION** button before starting the game.

<b>In Icon</b>	<b>Out Icon</b>	<b>Selection</b>
OFF	OFF	Any Segment In/Any Segment Out
ON	OFF	Double In/Any Segment Out
OFF	ON	Any Segment In/Double Out
ON	ON	Double In/Double Out

5. Press **PLAY/NEXT** button to start a game. Players need to press the **PLAY/NEXT** button to change players during games.
6. If a dart thrown at the dartboard scores, but does not stick in the board, the score can be eliminated. Press the **BOUNCE** button to eliminate this score. The score is eliminated but the dart will count as a dart thrown.
7. When a game is over the player number and rank will be displayed. Press the **PLAY/NEXT** button to display all the standings.
8. If the dartboard is idle for 3 minutes it will go into standby mode. This is an energy saving feature. Press any button to return to a game.
9. To turn the dartboard OFF, press and hold the **POWER** button for 3 seconds.

**SIRIUS ELECTRONIC GAME DESCRIPTIONS AND RULES**

**G01 Count Up (with scoring options of 100, 200, 300, 400, 500, 600, 700, 800, 900)**

The scoring options are the set points which are the points needed to win, see the chart below.

<b>Scoring Option</b>	100	200	300	400	500	600	700	800	900
<b>Set Points</b>	100	200	300	400	500	600	700	800	900

Refer to the section “Read First - Operation”.

**Playing the Game**

To win: The first player to reach or go over the set points will be the winner.

- Your score will be accumulated for each dart.

**G02 301 Count-Down**

**Game Options:**

- Single In/Single Out
- Double In/Single Out
- Double In/Double Out
- Single In/Double Out

Refer to the section “Read First - Operation”.

**Playing the Game**

To win: The first player who reaches exactly zero wins.

- The score will be deducted for each dart that scores.
- For **Single In** or **Single Out** options, the game can be started or ended by throwing at any segment, regardless if single, double or triple.
- If you select **Double In**, you must hit a double segment to start the game.
- If you select **Double Out** you must hit the double segment, that brings your score to zero, to end the game.

## G03 501 Count-Down

### Game Options:

Single In/Single Out  
Double In/Single Out  
Double In/Double Out  
Single In/Double Out

Refer to the section "Read First - Operation".

### Playing the Game

To win: The first player who reaches exactly zero wins.

- The score will be deducted for each dart that scores.
- For **Single In** or **Single Out** options, the game can be started or ended by throwing at any segment, regardless if single, double or triple.
- If you select **Double In**, you must hit a double segment to start the game.
- If you select **Double Out** you must hit the double segment, that brings your score to zero, to end the game.

## G04 601 Count-Down

### Game Options:

Single In/Single Out  
Double In/Single Out  
Double In/Double Out  
Single In/Double Out

Refer to the section "Read First - Operation".

### Playing the Game

To win: The first player who reaches exactly zero wins.

- The score will be deducted for each dart that scores.
- For **Single In** or **Single Out** options, the game can be started or ended by throwing at any segment, regardless if single, double or triple.
- If you select **Double In**, you must hit a double segment to start the game.
- If you select **Double Out** you must hit the double segment, that brings your score to zero, to end the game.

## G05 701 Count-Down

### Game Options:

- Single In/Single Out
- Double In/Single Out
- Double In/Double Out
- Single In/Double Out

Refer to the section "Read First - Operation".

### Playing the Game

To win: The first player who reaches exactly zero wins.

- The score will be deducted for each dart that scores.
- For **Single In** or **Single Out** options, the game can be started or ended by throwing at any segment, regardless if single, double or triple.
- If you select **Double In**, you must hit a double segment to start the game.
- If you select **Double Out** you must hit the double segment, that brings your score to zero, to end the game.

## G06 801 Count-Down

### Game Options:

- Single In/Single Out
- Double In/Single Out
- Double In/Double Out
- Single In/Double Out

Refer to the section "Read First - Operation".

### Playing the Game

To win: The first player who reaches exactly zero wins.

- The score will be deducted for each dart that scores.
- For **Single In** or **Single Out** options, the game can be started or ended by throwing at any segment, regardless if single, double or triple.
- If you select **Double In**, you must hit a double segment to start the game.
- If you select **Double Out** you must hit the double segment, that brings your score to zero, to end the game.

**G07 901 Count-Down****Game Options:**

Single In/Single Out  
Double In/Single Out  
Double In/Double Out  
Single In/Double Out

Refer to the section "Read First - Operation".

**Playing the Game**

To win: The first player who reaches exactly zero wins.

- The score will be deducted for each dart that scores.
- For **Single In** or **Single Out** options, the game can be started or ended by throwing at any segment, regardless if single, double or triple.
- If you select **Double In**, you must hit a double segment to start the game.
- If you select **Double Out** you must hit the double segment, that brings your score to zero, to end the game.

**G08 301 League Count-Down****Game Options:**

Single In/Single Out  
Double In/Single Out  
Double In/Double Out  
Single In/Double Out

Refer to the section "Read First - Operation".

**Playing the Game**

To win: The team will win when one player's score reaches exactly zero, and his teammate's score is lower than or equal to the sum of the score of the opposing team.

- This game is played by 2 teams who compete with each other. Each team has 2 members. Team 1 is made up of Player 1 and Player 3. Team 2 is made up of Player 2 and Player 4.
- The team will win when one player's score reaches exactly zero, and his teammate's score is lower than or equal to the sum of the score of the opposing team. Otherwise the score of the current player returns to the beginning of the turn. That team cannot win at that time.
- For **Single In** or **Single Out** options, the game can be started or ended by throwing at any segment, regardless if single, double or triple.
- If you select **Double In**, you must hit a double segment to start the game.
- If you select **Double Out** you must hit a double segment to end the game.



**G09 501 League Count-Down****Game Options:**

- Single In/Single Out
- Double In/Single Out
- Double In/Double Out
- Single In/Double Out

Refer to the section “Read First - Operation”.

**Playing the Game**

To win: The team will win when one player’s score reaches exactly zero, and his teammate's score is lower than or equal to the sum of the score of the opposing team.

- This game is played by 2 teams who compete with each other. Each team has 2 members. Team 1 is made up of Player 1 and Player 3. Team 2 is made up of Player 2 and Player 4.
- Similar to 301 Count Down, the team will win when one player’s score reaches exactly zero, and his teammate's score is lower than or equal to the sum of the score of the opposing team. Otherwise the score of the current player returns to the beginning of the turn. That team cannot win at that time.
- For **Single In** or **Single Out** options, the game can be started or ended by throwing at any segment, regardless if single, double or triple.
- If you select **Double In**, you must hit a double segment to start the game.
- If you select **Double Out** you must hit a double segment to end the game.

**G10 601 League Count-Down****Game Options:**

Single In/Single Out  
Double In/Single Out  
Double In/Double Out  
Single In/Double Out

Refer to the section "Read First - Operation".

**Playing the Game**

To win: The team will win when one player's score reaches exactly zero, and his teammate's score is lower than or equal to the sum of the score of the opposing team.

- This game is played by 2 teams who compete with each other. Each team has 2 members. Team 1 is made up of Player 1 and Player 3. Team 2 is made up of Player 2 and Player 4.
- Similar to 301 Count Down, the team will win when one player's score reaches exactly zero, and his teammate's score is lower than or equal to the sum of the score of the opposing team. Otherwise the score of the current player returns to the beginning of the turn. That team cannot win at that time.
- For **Single In** or **Single Out** options, the game can be started or ended by throwing at any segment, regardless if single, double or triple.
- If you select **Double In**, you must hit a double segment to start the game.
- If you select **Double Out** you must hit a double segment to end the game.

**G11 701 League Count-Down****Game Options:**

- Single In/Single Out
- Double In/Single Out
- Double In/Double Out
- Single In/Double Out

Refer to the section “Read First - Operation”.

**Playing the Game**

To win: The team will win when one player’s score reaches exactly zero, and his teammate's score is lower than or equal to the sum of the score of the opposing team.

- This game is played by 2 teams who compete with each other. Each team has 2 members. Team 1 is made up of Player 1 and Player 3. Team 2 is made up of Player 2 and Player 4.
- Similar to 301 Count Down, the team will win when one player’s score reaches exactly zero, and his teammate's score is lower than or equal to the sum of the score of the opposing team. Otherwise the score of the current player returns to the beginning of the turn. That team cannot win at that time.
- For **Single In** or **Single Out** options, the game can be started or ended by throwing at any segment, regardless if single, double or triple.
- If you select **Double In**, you must hit a double segment to start the game.
- If you select **Double Out** you must hit a double segment to end the game.

**G12 801 League Count-Down****Game Options:**

Single In/Single Out  
Double In/Single Out  
Double In/Double Out  
Single In/Double Out

Refer to the section "Read First - Operation".

**Playing the Game**

To win: The team will win when one player's score reaches exactly zero, and his teammate's score is lower than or equal to the sum of the score of the opposing team.

- This game is played by 2 teams who compete with each other. Each team has 2 members. Team 1 is made up of Player 1 and Player 3. Team 2 is made up of Player 2 and Player 4.
- Similar to 301 Count Down, the team will win when one player's score reaches exactly zero, and his teammate's score is lower than or equal to the sum of the score of the opposing team. Otherwise the score of the current player returns to the beginning of the turn. That team cannot win at that time.
- For **Single In** or **Single Out** options, the game can be started or ended by throwing at any segment, regardless if single, double or triple.
- If you select **Double In**, you must hit a double segment to start the game.
- If you select **Double Out** you must hit a double segment to end the game.

**G13 901 League Count-Down**

**Game Options:**

- Single In/Single Out
- Double In/Single Out
- Double In/Double Out
- Single In/Double Out

Refer to the section “Read First - Operation”.

**Playing the Game**

To win: The team will win when one player’s score reaches exactly zero, and his teammate's score is lower than or equal to the sum of the score of the opposing team.

- This game is played by 2 teams who compete with each other. Each team has 2 members. Team 1 is made up of Player 1 and Player 3. Team 2 is made up of Player 2 and Player 4.
- Similar to 301 Count Down, the team will win when one player’s score reaches exactly zero, and his teammate's score is lower than or equal to the sum of the score of the opposing team. Otherwise the score of the current player returns to the beginning of the turn. That team cannot win at that time.
- For **Single In** or **Single Out** options, the game can be started or ended by throwing at any segment, regardless if single, double or triple.
- If you select **Double In**, you must hit a double segment to start the game.
- If you select **Double Out** you must hit a double segment to end the game.

**G14 Round-The-Clock (with scoring options of 105, 110, 115, 120, 205, 210, 215, 220, 305, 310, 315, 320)**

The scoring options are the last number that will be thrown and the segment that must be hit, see the chart below.

<b>Scoring Option</b>	105	110	115	120				
<b>Last Number Thrown</b>	5	10	15	20				
	Can hit any segment							
<b>Scoring Option</b>	205	210	215	220	305	310	315	320
<b>Last Number Thrown</b>	5	10	15	20	5	10	15	20
	Must hit only Double segments				Must hit only Triple segments			

Refer to the section “Read First - Operation”.

**Playing the Game**

To win: The first player to reach the final number in the sequence will be the winner.

- Players must hit in strict order of 1, 2, 3...until 5, 10, 15, or 20, single, double or triple, depending on the scoring option selected.
- Should a wrong number or segment be hit during the round, the player has to continue with the same target for the next darts.
- The display will show the number or segment the player must hit.

**G15 Simple Cricket (with scoring options of 000, 020, 025)**

The scoring options are described in the chart below.





Scoring Options	Description
000	Hit and open numbers 15-20 and bullseye in any order.
020	Hit and open the number 20 first, then in order, open numbers 19, 18, 17, 16, 15 and bullseye.
025	Hit and open bullseye first, then in order, open numbers 15, 16, 17, 18, 19 and 20.

Refer to the section “Read First - Operation”.

**Playing the Game**

To win: The first player to hit each number 3 times and open them all is the winner.

**Note:** A single segment counts as one hit, a double segment counts as two hits and a triple segment counts as three hits.

Cricket Status	One Time	Two Times	Open	Close
Sign				

- In Simple Cricket only the numbers 15-20 and bullseye are used.
- If every player has opened a number, that number will then close.
- All valid hits will be confirmed and displayed by the Cricket Display.

**G16 Standard Cricket (with scoring options of C00, C20, C25)**

The scoring options are described in the chart below.





Scoring Options	Description
C00	Hit and open numbers 15-20 and bullseye in any order.
C20	Hit and open the number 20 first, then in order, open numbers 19, 18, 17, 16, 15 and bullseye.
C25	Hit and open bullseye first, then in order, open numbers 15, 16, 17, 18, 19 and 20.

Refer to the section “Read First - Operation”.

**Playing the Game**

To win: A player wins the game when he first opens all the numbers and has an equal or greater score than the other players. However, if players are tied on points, or have no points, the first player to open all numbers wins.

**Note:** A single segment counts as one hit, a double segment counts as two hits and a triple segment counts as three hits.

Cricket Status	One Time	Two Times	Open	Close
Sign				

- In Standard Cricket only the numbers 15-20 and bullseye are used.
- All valid hits will be confirmed and displayed by the Cricket Display.
- When a number has been hit 3 times by a player, it is then open to that player and any further hits by that player will score points.
- Once a number has been hit 3 times by all the players, that number is then closed and can no longer be scored upon by any player. At that time the indicator will change to closed for that number.
- A player who has opened a number can continue to score on that number until it becomes closed.
- If a player has opened all numbers first, but is behind on points, scoring continues on open numbers. If that player has not accumulated the highest point total by the time another player opens all their numbers, the player with the most points will be the winner.
- If players are tied on points, or have no points, the first player to open all numbers wins.

**G17 Cut Throat Cricket (with scoring options of 00C, 20C, 25C)**

The scoring options are described in the chart below.





Scoring Options	Description
00C	Hit and open numbers 15-20 and bullseye in any order.
20C	Hit and open the number 20 first, then in order, open numbers 19, 18, 17, 16, 15 and bullseye.
25C	Hit and open bullseye first, then in order, open numbers 15, 16, 17, 18, 19 and 20.

Refer to the section “Read First - Operation”.

**Playing the Game**

To win: The player who first opens all numbers and has the lower score wins.

**Note:** A single segment counts as one hit, a double segment counts as two hits and a triple segment counts as three hits.

Cricket Status	One Time	Two Times	Open	Close
Sign				

- In Cut Throat Cricket only the numbers 15-20 and bullseye are used.
- If every player has opened a number, that number will then close.
- All valid hits will be confirmed and displayed by the Cricket Display.
- Once the scoring begins, points are added to your opponents' scores who haven't opened that number.



**G18 Scram Cricket**

Refer to the section “Read First - Operation”.

**Playing the Game**

To win: During round 2, if Player 1’s score goes over Player 2’s score the game will end and Player 1 will be the winner. If Player 2 closes all the numbers and has a higher score than Player 1, Player 2 will be the winner.

**Note:** A single segment counts as one hit, a double segment counts as two hits and a triple segment counts as three hits.

Cricket Status	One Time	Two Times	Open	Close
Sign	\	X	⊗	○

- All valid hits will be confirmed and displayed by the Cricket Display.
- The game consists of 2 rounds. In the first round, player 1 must close 15 through 20 and bullseye while player 2 attempts to get as high a score as he can by scoring on the open numbers. Round 1 will be finished when all numbers have been closed. For round 2, the reverse is done. Player 2 attempts to close 15 through 20 and the bullseye. Player 1 attempts to get a high score.
- During round 2, if Player 1’s score goes over Player 2’s score the game will end and Player 1 will be the winner. If Player 2 closes all the numbers and has a higher score than Player 1, Player 2 will be the winner.

**G 19 Hi Score (with scoring options of H03, H04, H05, H06, H07, H08, H09, H10, H11, H12)**

The scoring options are the number of rounds, see the chart below.

Scoring Option	H03	H04	H05	H06	H07	H08	H09	H10	H11	H12
<b>No. of Rounds</b>	3	4	5	6	7	8	9	10	11	12

Refer to the section “Read First - Operation”.

**Playing the Game**

To win: The player with the highest score at the end of all the rounds wins.

- The rules are simple. A player must rack up the most points in 3, 4, 5...or 12 rounds (each round is 3 darts) to win.
- Doubles and triples count as 2 times and 3 times that number’s score respectively.
- The cricket display will count the rounds.

**G20 Shoot Out (with scoring options of -11, -12, -13, -14, -15, -16, -17, -18, -19, -20)**

The scoring options are the number of targets you must hit, see the chart below.

<b>Scoring Option</b>	-11	-12	-13	-14	-15	-16	-17	-18	-19	-20
<b>No. of Targets</b>	11	12	13	14	15	16	17	18	19	20

Refer to the section “Read First - Operation”.

**Playing the Game**

To win: The first player who hits the number of correct targets, depending on the option selected, is the winner.

- The e-BOARD Computer will randomly select a number (target) for the player to hit.
- One correct hit on a segment of the displayed number subtracts one from the score.
- Single, double and triple segments all count as one hit.
- If a player does not hit the selected number within 10 seconds, the dart is regarded as a miss and the e-BOARD Computer will automatically select another random number for the player to hit for the next dart.

**G21 Shanghai (with scoring options of L01, L05, L10, L15, H01, H05, H10, H15, P01, P05, P10, P15)**

The scoring options are described in the chart below.

<b>Scoring Option</b>	L01	L05	L10	L15	H01	H05	H10	H15	P01	P05	P10	P15
<b>Game starts on number</b>	1	5	10	15	1	5	10	15	1	5	10	15
	Can hit any segment				Must hit double or triple segments				Various doubles and triples must be hit as specified by the computer			

Refer to the section “Read First - Operation”.

**Playing the Game**

To win: The player who gets the most points at the end of the game wins.

- Each player must hit the numbers and the bullseye in order. The starting number changes based on the scoring option selected.
- The target number for each turn will change by one, ending with the bullseye.
- The dartboard will display the target number you are supposed to hit.
- Throw 3 darts for each number and the player who gets the most points at the end of the game wins.
- Your score is the number of the segment you are on.
- Hitting a double segment in the number you are on will double your points, likewise a triple will triple your points. For example if you are on number 4 and you hit a single in segment 4 you get 4 points. If you are on number 4 and you hit a double segment 4 you get 8 points.

**G22 Double Down**

Refer to the section “Read First - Operation”.

**Playing the Game**

To win: The player with the highest score after the last round is the winner.

- This game starts with a base score of 60 points for each player.
- There are 9 rounds for each player. Each round has a number or segment that you must hit in order to score.
- The dartboard will display what number you must hit for that round. The designated numbers for each round are:

Round	1	2	3	4	5	6	7	8	9
Target Number	15	16	Any Double	17	18	Any Triple	19	20	Bullseye

- Each dart that hits the correct number will score points based on the number and the segment. For example, if you hit number 15 single segment you will get 15 points. If you hit the number 15 double segment you would get 30 points. If you hit the number 15 triple segment you would get 45 points.
- If the player does not hit the designated number during their round their score is cut in half and they move on to the next round on their next turn.
- For the Any Double and Any Triple, the player must hit any double or triple segment. If the doubles and triples are not hit, the player's score is cut in half.

**G23 Forty One**

Refer to the section “Read First - Operation”.

**Playing the Game**

To win: The player with the highest score after the last round is the winner.

- This game is the same as Double Down except the sequence for the rounds is reversed from number 20 to the bullseye.
- The dartboard will display what number you must hit for that round. The designated numbers for each round are:

Round	1	2	3	4	5	6	7	8	9	10
Target Number	20	19	Any Double	18	17	Any Triple	16	15	“41” Points	Bullseye

- The additional round of 41 points is included before the bullseye, and a player must hit any 3 segments totaling 41.

**G24 All Fives (with scoring options of 551, 561, 581, 591)**

The scoring options are the total points you need to win, see the chart below.

<b>Scoring Option</b>	551	561	571	581	591
<b>Total Points</b>	51	61	71	81	91

Refer to the section “Read First - Operation”.

**Playing the Game**

To win: The first player to score 51, 61, 71, 81, or 91 will be the winner.

- During each round the player’s total score must be divisible by 5. Every divisible 5 counts as one point. For instance, 2, 8, 5 totals 15. A player will get 3 points as 15 divided by 5 equals 3.
- There will be no points if the round of 3 darts total score is not divisible by 5 or any darts miss, even though the sum of the other 2 darts score is divisible by 5.
- The display will show the best segment to hit and score points.

**G25 Big-6 (with scoring options of 3, 4, 5, 6, 7)**

The scoring options are the number of lives you start with, see the chart below.

<b>Scoring Option</b>	3	4	5	6	7
<b>No. of Lives</b>	3	4	5	6	7

Refer to the section “Read First - Operation”.

**Playing the Game**

To win: If a player loses all their lives they are out of the game. The remaining players continue the game until one player is left with lives. That player is the winner.

- This game allows a player to challenge opponents to hit the targets of the player’s choice. However, players must earn the chance of picking the next target for their opponent by making a hit on the current target first.
- The game begins with the single 6 segment as the target. The player that hits this segment first saves a life and can then hit any segment they want. That segment then becomes the target.
- In any turn if the player does not hit the target they loose one life.
- If a player hits the target with the first or second dart, the next dart then determines the next target and that player’s turn is over. If a player hits the target with the third dart their turn is over and the target stays the same. A life is not lost.
- If a player loses all their lives they are out of the game. The remaining players continue the game until one player is left with lives.

**G26 Overs (with scoring options of 0-7, 0-8, 0-9)**

The scoring options are the number of lives you start with, see the chart below.

<b>Scoring Option</b>	0-7	0-8	0-9
<b>No. of Lives</b>	7	8	9

Refer to the section “Read First - Operation”.

**Playing the Game**

To win: The last player with lives remaining is the winner.

- Each player takes a turn throwing 3 darts, the highest score among the players will become the “leader’s score”.
- A player’s score will become a new “leader’s score” if his score in the new turn is higher than the previous “leader’s score”. If not, he will lose one life.
- If a leader does not want to challenge and wants to keep his “leader’s score”, he can press the PLAY/NEXT button and skip his turn.
- After a player throws, if they do not have a new “leader’s score”, a life will be lost.
- A leader can choose to challenge his own “leader’s score” but he will also lose a life if his score is lower than the leader’s score.
- If a player loses all their lives they are out of the game.
- The remaining players continue the game until one player is left with lives.

**G27 Unders (with scoring options of U-7, U-8, U-9)**

The scoring options are the number of lives you start with, see the chart below.

<b>Scoring Option</b>	U-7	U-8	U-9
<b>No. of Lives</b>	7	8	9

Refer to the section “Read First - Operation”.

**Playing the Game**

To win: The last player with lives remaining is the winner..

- The rules follow exactly as Over except the “Leader’s Score” is the lowest score for each turn.
- A missed dart should be counted as 60 by pressing the Triple 20 segment.

**G28 Baseball (with scoring options of b07, b08, b09)**

The scoring options are the number of innings, see the chart below.

<b>Scoring Option</b>	b07	b08	b09
<b>No. of Lives</b>	7	8	9

Refer to the section “Read First - Operation”.

**Playing the Game**

To win: The player with the most runs at the end of the game is the winner.

- A baseball field is laid out as shown in diagram below. A player throws 3 darts in each inning and the runs/bases are set as follows:

<b>Segments</b>	<b>Result</b>
Single	One Base
Double	Two Bases
Triple	Three Bases
Bullseye	Home Run

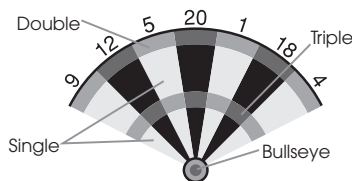

- A home run can only be scored on the 3rd dart of each turn.
- The LCD display will show what base your “runners” are on and the number of innings left. The table below will show the symbols displayed for the base that your “runner” is on.

1st Base	2nd Base	3rd Base	Home
\	X	⊗	○

**G29 By 5’s©**

Refer to the section “Read First - Operation”.

**Playing the Game**

To win: The first player to get to 60 is the winner.

- Players must score in multiples of 5 with a single dart.
- Start with a dart totaling 5 then a dart of 10 and so on up to 60.
- The display will show the next number that must be scored.
- Score in order 5, 10, 15, 20, 25, 30, 40, 45, 50, 60.
- Doubles and triples must be used to score the higher numbers.

**G30 By 10's©**

Refer to the section "Read First - Operation".

**Playing the Game**

To win: The first player to score 60 then return back to 10 is the winner.

- Same basic game as By 5's EXCEPT players must score in multiples of 10 with a single dart.
- Start with a 10 then 20 and so on up to 60.
- When 60 is reached, reverse the order and return to 10.
- Score in order 10, 20, 30, 40, 50, 60, 60, 50, 40, 30, 20, 10.

**G31 By Odds's©**

Refer to the section "Read First - Operation".

**Playing the Game**

To win: The first player to reach and score 19 and return to 1 is the winner.

- Same basic game as By 5's EXCEPT players score with odd numbers.
- Players score starting with 1, then scoring the odd numbers up to 19. when 19 is reached, reverse the order and return to 1.
- Score in order 1, 3, 5, 7, 9, 11, 13, 15, 17, 19, 19, 17, 15, 13, 11, 9, 7, 5, 3, 1.

**G32 Killer (with scoring options of 003, 005, 007, 009, 011, 013, 015, 017, 019, 021, 203, 205, 207, 209, 211, 213, 215, 217, 219, 221, 303, 305, 307, 309, 311, 313, 315, 317, 319, 321)**

The scoring options are the number of lives you have and what segments to hit for a kill, see the chart below.

<b>Scoring Option</b>	003	005	007	009	011	013	015	017	019	021
<b>No. of Lives</b>	3	5	7	9	11	13	15	17	19	21
	Hit Single, Double or Triple to become a killer.									
<b>Scoring Option</b>	203	205	207	209	211	213	215	217	219	221
<b>No. of Lives</b>	3	5	7	9	11	13	15	17	19	21
	Must hit Doubles only to become a killer. Single or Triple count as a miss.									
<b>Scoring Option</b>	303	305	307	309	311	313	315	317	319	321
<b>No. of Lives</b>	3	5	7	9	11	13	15	17	19	21
	Must hit Triples only to become a killer. Single or Double count as a miss.									

Refer to the section "Read First - Operation".

**Playing the Game**

To win: The last player with “Lives” will be the winner.

- To start this game, players throw a dart at the dartboard to select their number.
- The dartboard display will show SEL. Select your number by throwing a dart at the dartboard. The number selected will be used for that player throughout the game. The number you select will display in your player's score display. No two players can select the same number in one game.
- To become a “Killer”, a player must hit the segment of their selected number.
- Once you become a “Killer” your score display will show a "K" in front of your selected number during your turn.
- Once you become a “Killer” you can then kill other players by hitting the segments of the number they picked until all their “Lives” are killed. Each hit can only “Kill” one “Life” regardless if it is a double or triple.
- Hitting your own number will take away one of your own lives.
- The number of “Lives” remaining will be displayed on the player’s cricket display.

**G33 9 Lives (with scoring options of 003, 004, 005, 006, 007, 008, 009)**

The scoring options are the number of lives you start with, see the chart below.

<b>Scoring Option</b>	003	004	005	006	007	008	009
<b>No. of Lives</b>	3	4	5	6	7	8	9

Refer to the section “Read First - Operation”.

**Playing the Game**

To win: The last player remaining alive is the winner.

- This game plays numbers 1 through 20 and bullseye in a sequence loop. Players take turns throwing at 1 in the first round, 2 in the second round, and so on, until “25” in the 21st round, 1 in the 22nd round and so on.
- Each player must hit the target number with one dart in each round.
- The cricket display will keep track of lives remaining.
- A player will lose a life if all 3 darts miss.



**G34 Halve-It**

There are twelve rounds of three darts each in this game. Each round has a target number you must hit to score points. The dartboard will display the number you need to hit for that round. The target numbers for each round are:

<b>Round</b>	1	2	3	4	5	6
<b>Target Number</b>	12	13	14	Any Double	15	16
<b>Round</b>	7	8	9	10	11	12
<b>Target Number</b>	17	Any Triple	18	19	20	Bullseye

Refer to the section “Read First - Operation”.

**Playing the Game**

To win: The player with the highest score after all twelve rounds wins.

- Players take turns throwing darts and attempting to score points.
- If you hit the target number for that round, you will get that number in points. Double segments will double your points and triple segments will triple your points. For example, in Round 1 you have to hit the number 12. If you hit it in a single segment you will get 12 points. If you hit the double 12 you will get 24 points and the triple 12 will give you 36 points.
- For Round 4 you can only score off any double segment.
- For round 8 you can only score off any triple segment and for Round 12 you can only score by hitting the bullseye.
- If a player misses the designated number on all three darts in a round, their total score is cut in half.

**G35 Bingo (with scoring options of 132, 141, 168, 189)**

The scoring options are described in the chart below.

<b>Scoring Options</b>	<b>Description</b>
132	Hit segments 15, 4, 8, 14, 3 in order.
141	Hit segments 17, 13, 9, 7, 1 in order.
168	Hit segments 20, 16, 12, 6, 2 in order.
189	Hit segments 19, 10, 18, 5, 11 in order.

Refer to the section “Read First - Operation”.

**Playing the Game**

To win: The player that hits the specified targets three times is the winner.

- The player should hit a number segment three times to enter into the next number segment.
- Hitting the single segment counts as one time; the double segment counts as two times; the triple segment counts as three times.
- The cricket display will keep track of the correct hits.

**G36 21 Points (with scoring options of 005, 006, 007, 008, 009, 010, 011)**

The scoring options are the number of rounds, see the chart below.

<b>Scoring Option</b>	005	006	007	008	009	010	011
<b>No. of Rounds</b>	5	6	7	8	9	10	11

Refer to the section “Read First - Operation”.

**Playing the Game**

To win: After the game is over, the player with the most marks wins the game.

- The object of this game is to get the most marks. A player can get one mark in two ways:
  1. Gets 21 points exactly with 1, 2 or 3 darts, or
  2. Has the highest points up to 21 points (if no one gets 21 points in this round)
- The player will ‘bust’ when a score is over 21 points and the player cannot get a mark.
- The cricket display keeps track of the rounds that are remaining.

**G37 Nine-Dart Century (with scoring options of 100, 150, 200)**

The scoring options are the target score, see the chart below.

<b>Scoring Option</b>	100	150	200
<b>Target Score</b>	100 Points	150 Points	200 Points

Refer to the section “Read First - Operation”.

**Playing the Game**

To win: The player that gets closest to the Target Score without going over is the winner.

- In this game each player has 9 darts (three turns) to score 100 (or 150, 200) points without going over, or get as close as possible.
- If you go over you are out of the game. The dartboard will announce “TOO HIGH”.
- Darts that land outside the scoring area will reset your score back down to zero. Press the MISSED DART button.
- Darts that bounce out are not penalized and do not count for any points.
- The number on the dartboard that you hit will be your score.
- A double segment is worth double points and a triple is worth triple.

**G38 Best of Nine (with scoring options of 009, 012, 015, 018, 021)**

The scoring options are the number of darts thrown, matched with the number of rounds for the game, see the chart below.

<b>Scoring Option</b>	009	012	015	018	021
<b>No. of Darts/Rounds</b>	9/3	12/4	15/5	18/6	21/7

Refer to the section “Read First - Operation”.

**Playing the Game**

To win: The player with the highest score at the end of the game wins.

- The dartboard will announce “PLAYER 1” and display a number for you to hit.
- The target number will change before each turn.
- Each player will take a turn throwing three darts.
- The object is to hit your assigned number.
- For every single segment hit in your number you will get one point. For every double segment hit in your number you will get two points and for every triple segment hit in your number you will get three points.
- The cricket display will count down how many rounds you have left.

**G39 Hound and Hare (with scoring options of 005, 012, 009, 014, 011)**

The scoring options are the Hound starting number, see the chart below.

<b>Scoring Option</b>	005	012	009	014	011
<b>Number Hound Starts At</b>	5	12	9	14	11

Refer to the section “Read First - Operation”.

**Playing the Game**

To win: If the “Hound” (Player 2) hits the same double number that the “Hare” (Player 1) is trying to hit, the “Hound” wins. If the “Hare” (Player 1) makes it back around the dartboard to the double 20, the “Hare” wins.

- The “Hare” (Player 1) tries to escape from the “Hound” (Player 2) while the “Hound” tries to catch the “Hare”.
- The “Hare” (Player 1), starts at the double 20.
- The dartboard will display what number you must hit.
- Only the double segments are used in this game.
- The “Hare” (Player 1) must hit the double 20 to move clockwise to the next number. The “Hound” (Player 2) will start at the double 5 (or 12, 9, 14, 11) segment. The “Hound” (Player 2) must hit the double 5 (or 12, 9, 14, 11) segment to move clockwise to the next number.
- The players continue to take turns throwing darts and moving around the dartboard.
- The object is for the “Hound” to catch up to the “Hare”.

**G40 Shooting I**

Refer to the section “Read First - Operation”.

**Playing the Game**

To win: Winner is the first one to win 7 rounds.

- In this game, each player throws three darts. The player with the highest 3 dart total wins that round.
- Double segments count as double the points and triple segments count as triple the points.

**G41 Shooting II**

Refer to the section “Read First - Operation”.

**Playing the Game**

To win: Winner is the first one to win 7 rounds.

- In this game, each player throws three darts. The player with the highest 3 dart total wins that round.
- Only darts that land in the single, double or triple areas of the following Target Area numbers will count towards the score: 15, 16, 17, 18, 19, 20 and bullseye.
- The cricket display will keep track of the rounds the player has won.
- Double segments count as double the points and triple segments count as triple the points.

**G42 Shooting III**

Refer to the section “Read First - Operation”.

**Playing the Game**

To win: The game lasts 7 rounds and the winner is the first one who won 4 rounds within 7 rounds or who won the most rounds after 7 rounds.

- In this game, each player throws three darts. The player with the highest 3 dart total wins that round.
- Double segments count as double the points and triple segments count as triple the points.

**G43 Shooting IV**

Refer to the section “Read First - Operation”.

**Playing the Game**

To win: The game lasts 7 rounds and the winner is the first one to win 4 rounds within 7 rounds or who won the most rounds after 7 rounds.

- In this game, each player throws three darts. The player with the highest 3 dart total wins that round.
- Only darts that land in the single, double, or triple areas of the following Target Area numbers will count towards the score: 15, 16, 17, 18, 19, 20, bullseye.
- Double segments count as double the points and triple segments count as triple the points.

This page left intentionally blank.

## ONE YEAR LIMITED WARRANTY

The Manufacturer warrants to the original retail purchaser that this product is free from defects in material and workmanship under normal use and conditions for a period of one year from the date of original purchase. The Manufacturer's liability is limited to the repair or replacement, at its option, of any defective product and shall not include any liability for indirect, incidental or consequential damages of any kind.

Should this product become defective due to material or workmanship within the warranty period, contact our Customer Service Department. This warranty is not transferable and does not cover normal wear and tear or damage caused by improper usage, negligence, misuse, abuse, transportation damage, acts of nature, or accident (including failure to follow the instructions in this manual). It does not cover expendable items such as batteries, light bulbs, fuses, accessories, cosmetic parts and other items that wear out due to normal usage, including felt covered areas of the playing surface. This warranty is also void if the product is disassembled and reassembled, damaged, modified from its original state, or used for other than indoor personal residential use (no commercial or rental applications). This warranty gives you specific legal rights, and you may have other rights which vary from state to state.

### **IF YOU HAVE A WARRANTY CLAIM, CALL US FIRST (8 - 4:30 CST):**

**Please have your receipt and item number (found on the front cover) when you call.**

#### ***GLD Products***

S84 W19093 Enterprise Drive  
Muskego, WI 53150 USA

1-800-225-7593

Fax: 1-800-841-6944

Email: [gld@gldmfg.com](mailto:gld@gldmfg.com)

Web: [www.gldproducts.com](http://www.gldproducts.com)

**If you are instructed to return the product for service, you are responsible for shipping the unit at your expense to the above address in packaging that will protect against further damage. All warranty or repair requests require a Return Authorization Number prior to returning the item.**

### **PRODUCT REGISTRATION**

**Important:** The product registration form on page 39 must be completed and returned along with a copy of your receipt within 10 days of purchase to validate your warranty.

On-line registration is also available.

Go to <http://www.gldproducts.com/index.php/registration> or click on this link. Follow the on-line instructions.

# REGISTER YOUR PRODUCT

Place postage here

Complete this form, include a copy of your receipt, fold, tape (do not staple) and return within 10 days of purchase. This protects your warranty and will help us develop new products!

Cut here.

**GLD Products**  
Warranty Department  
S84 W19093 Enterprise Drive  
Muskego, WI 53150 USA

Fold here second.



[www.gldproducts.com](http://www.gldproducts.com)

- |                       |                            |
|-----------------------|----------------------------|
| GAME TABLES           | HOME CASINO                |
| GAMES AND ACCESSORIES | BILLIARD CUES              |
| BILLIARD ACCESSORIES  | DARTBOARDS                 |
| SOFT-TIP DARTS        | STEEL-TIP DARTS            |
| FLIGHTS AND SHAFTS    | DART CASES AND ACCESSORIES |

Fold here first.

Name	Date of Purchase
Address	Phone-Day
City	Phone-Evening
State                      Zip	Email
Purchase Price:	Item: <b>42-1029 A Sirius Electronic Dartboard</b>
Store Name:	

**Remember to attach a copy of your receipt.**

This page left intentionally blank.





[www.gldproducts.com](http://www.gldproducts.com)

**GAME TABLES**

**HOME CASINO**

**GAMES AND ACCESSORIES**

**BILLIARD CUES**

**BILLIARD ACCESSORIES**

**DARTBOARDS**

**SOFT-TIP DARTS**

**STEEL-TIP DARTS**

**FLIGHTS AND SHAFTS**

**DART CASES AND ACCESSORIES**



**PROUD MANUFACTURER OF**

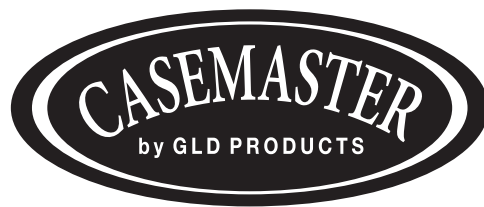

*Yesterday's games for today's families!*  
by GLD Products

S84 W19093 Enterprise Drive • Muskego, WI 53150 USA  
262.679.8730 or 1.800.225.7593 tele  
262.679.8738 or 1.800.841.6944 fax  
Email: [gld@gldmfg.com](mailto:gld@gldmfg.com)  
[www.gldproducts.com](http://www.gldproducts.com)

Game	Name	Options	Players	In/Out Single/Double
G01	Count Up	9	1-8	N/A
G02	301	4	1-8	Yes
G03	501	4	1-8	Yes
G04	601	4	1-8	Yes
G05	701	4	1-8	Yes
G06	801	4	1-8	Yes
G07	901	4	1-8	Yes
G08	301 League	4	4	Yes
G09	501 League	4	4	Yes
G10	601 League	4	4	Yes
G11	701 League	4	4	Yes
G12	801 League	4	4	Yes
G13	901 League	4	4	Yes
G14	Round-The-Clock	12	1-8	N/A
G15	Simple Cricket	3	1-8	N/A
G16	Standard Cricket	3	1-8	N/A
G17	Cut Throat Cricket	3	1-8	N/A
G18	Scram Cricket	1	2	N/A
G19	Hi-Score	10	1-8	N/A
G20	Shoot Out	10	1-8	N/A
G21	Shanghai	12	1-8	N/A
G22	Double Down	1	1-8	N/A
G23	Forty One	1	1-8	N/A
G24	All Fives	5	1-8	N/A
G25	Big 6	5	1-8	N/A
G26	Overs	3	2-8	N/A
G27	Unders	3	2-8	N/A
G28	Baseball	3	1-8	N/A
G29		1	1-8	N/A
G30	By 10's©	1	1-8	N/A
G31	By Odd's©	1	1-8	N/A
G32	Killer	30	2-8	N/A
G33	9 lives	7	2-8	N/A
G34	Halve-It	1	1-8	N/A
G35	Bingo	4	1-8	N/A
G36	21 Points	7	1-8	N/A
G37	Nine Dart Century	3	1-8	N/A
G38	Best of Nine	5	1-8	N/A
G39	Hound and Hare	5	2	N/A
G40	Shooting I	1	1-8	N/A
G41	Shooting II	1	1-8	N/A
G42	Shooting III	1	1-8	N/A
G43	Shooting IV	1	1-8	N/A

**Quick Reference For Sirius Dashboard Item 42-1029 A**

<b>In Icon</b>	<b>Out Icon</b>	<b>Selection</b>
OFF	OFF	Any Segment In/Any Segment Out
ON	OFF	Double In/Any Segment Out
OFF	ON	Any Segment In/Double Out
ON	ON	Double In/Double Out